

The reservoir

General aspect

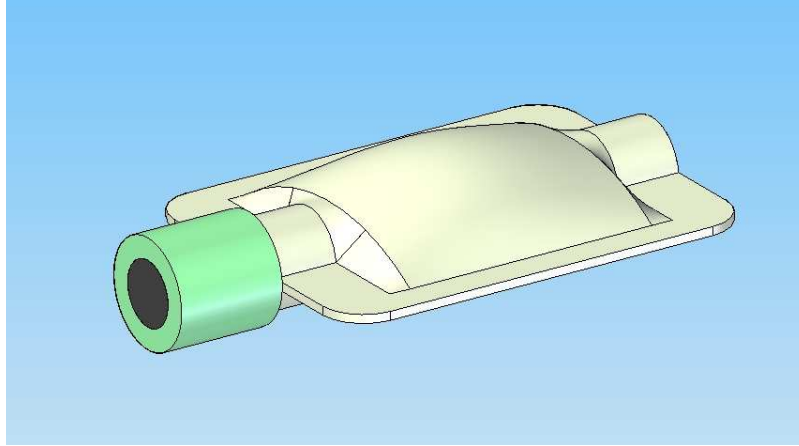

Parts and materials

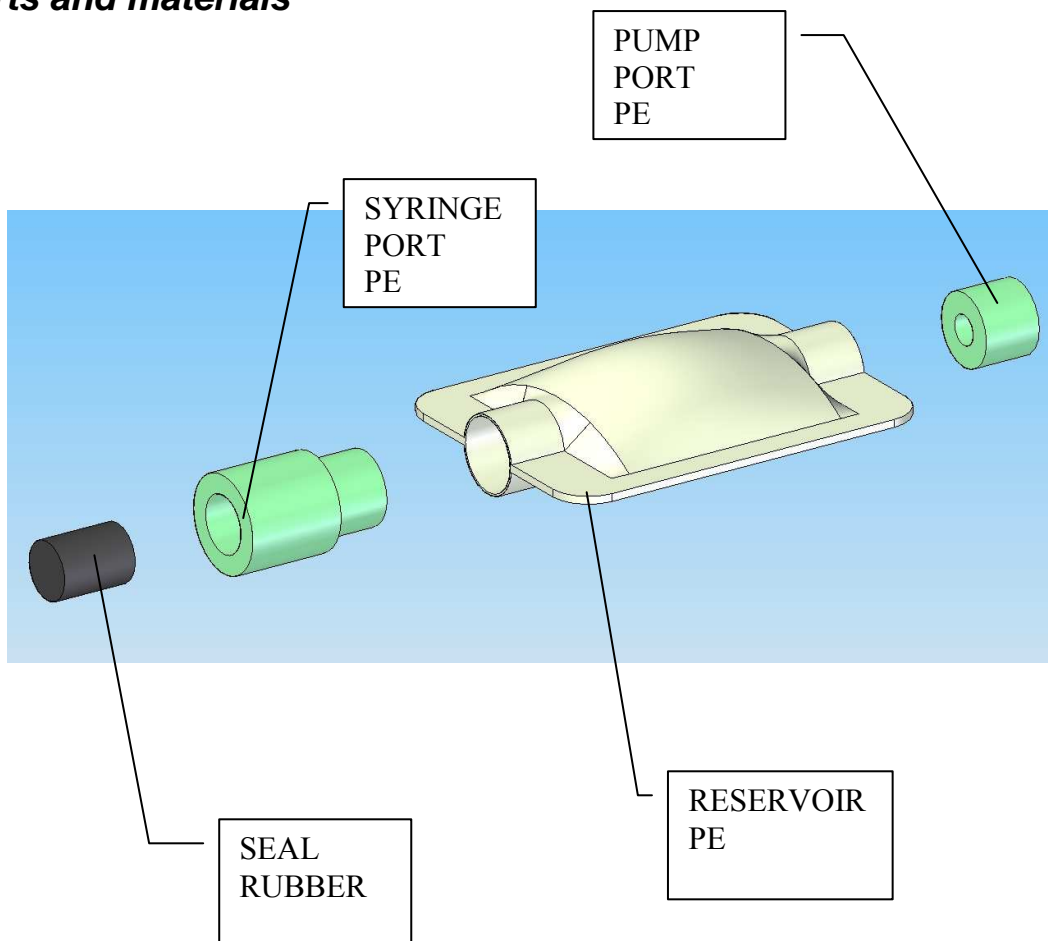

Assembly

Before Welding

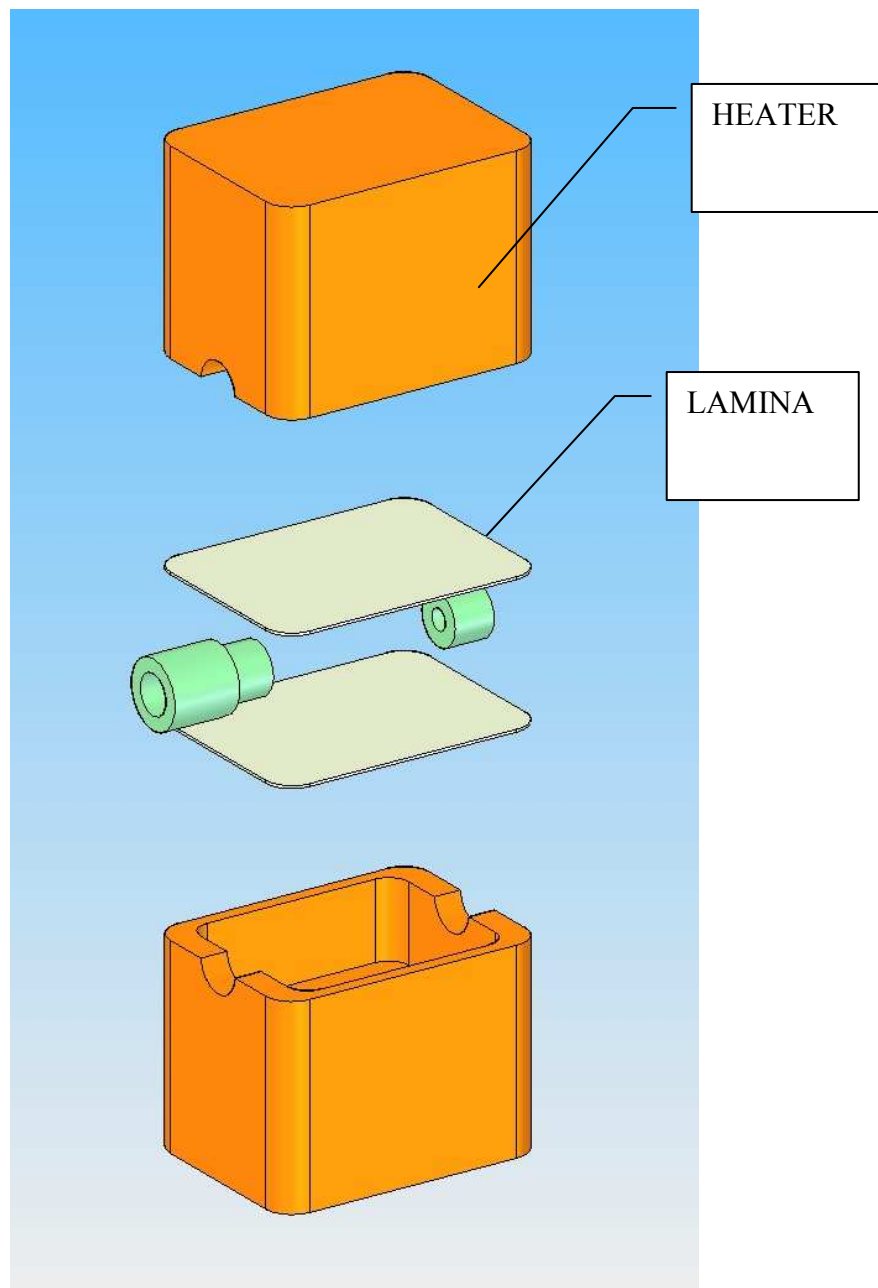

Welding

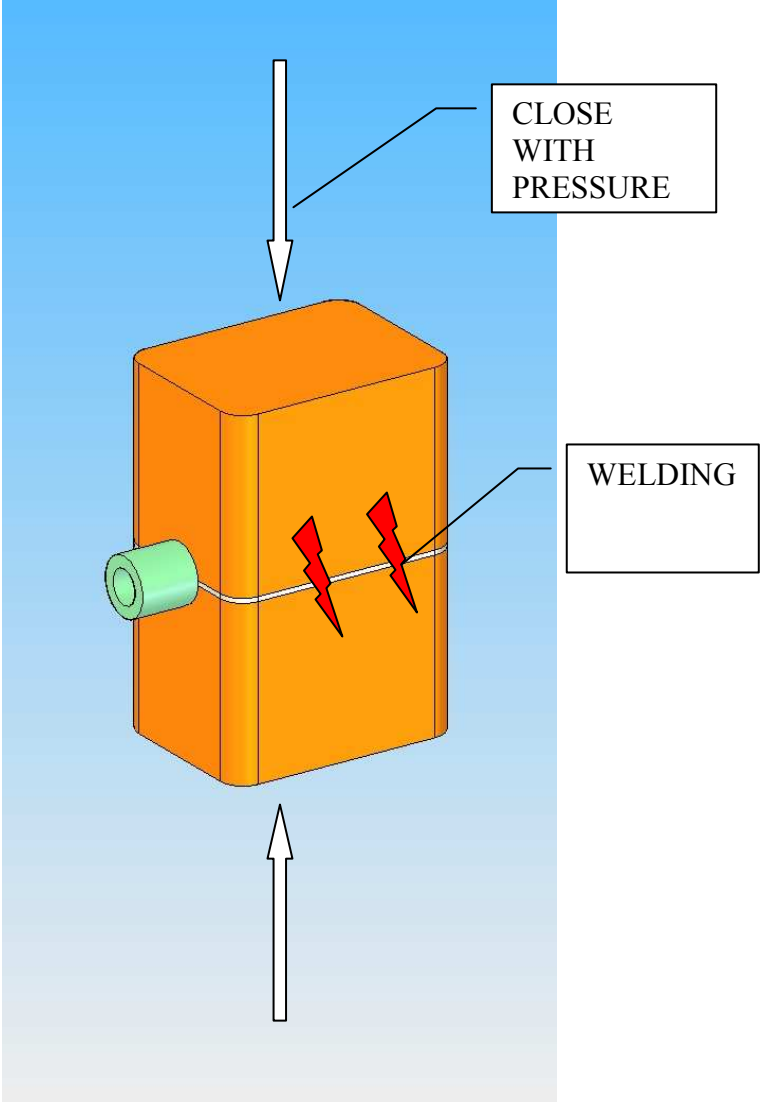

Alter Welding

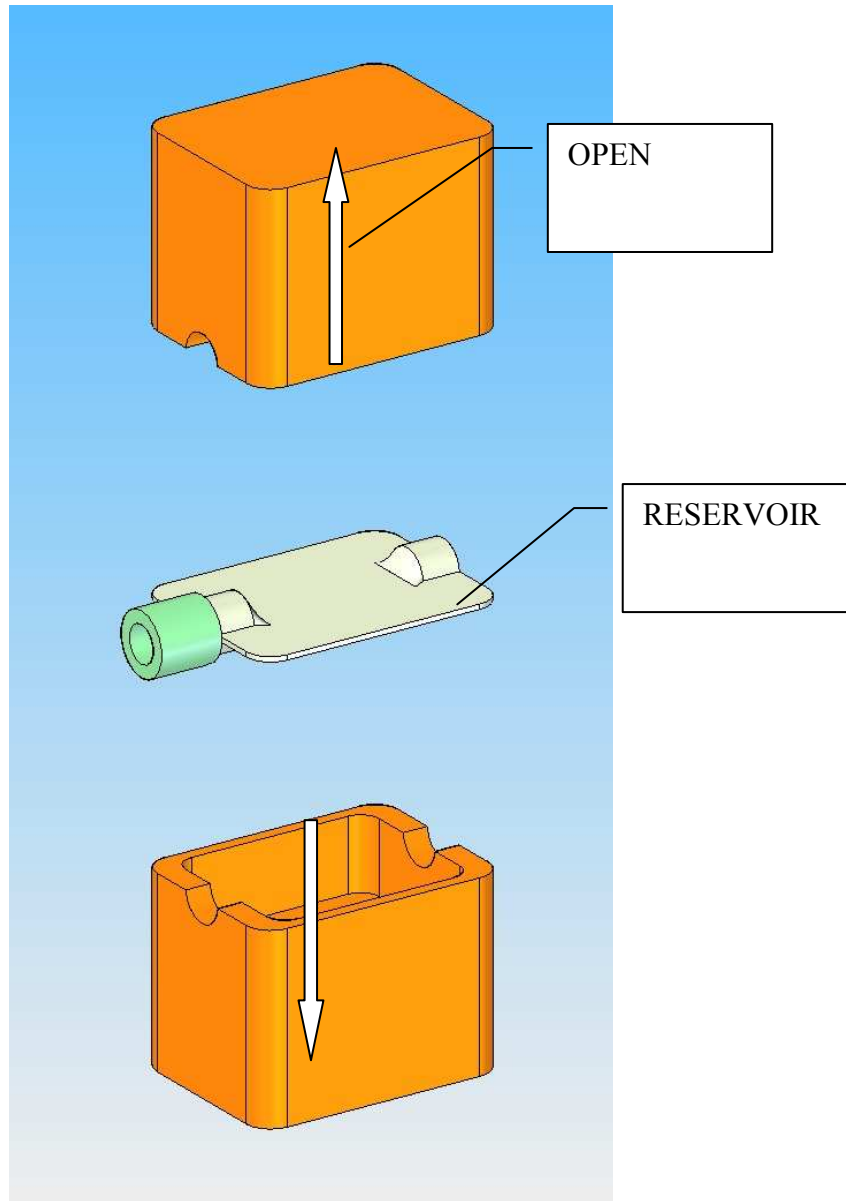

Mounting the seal

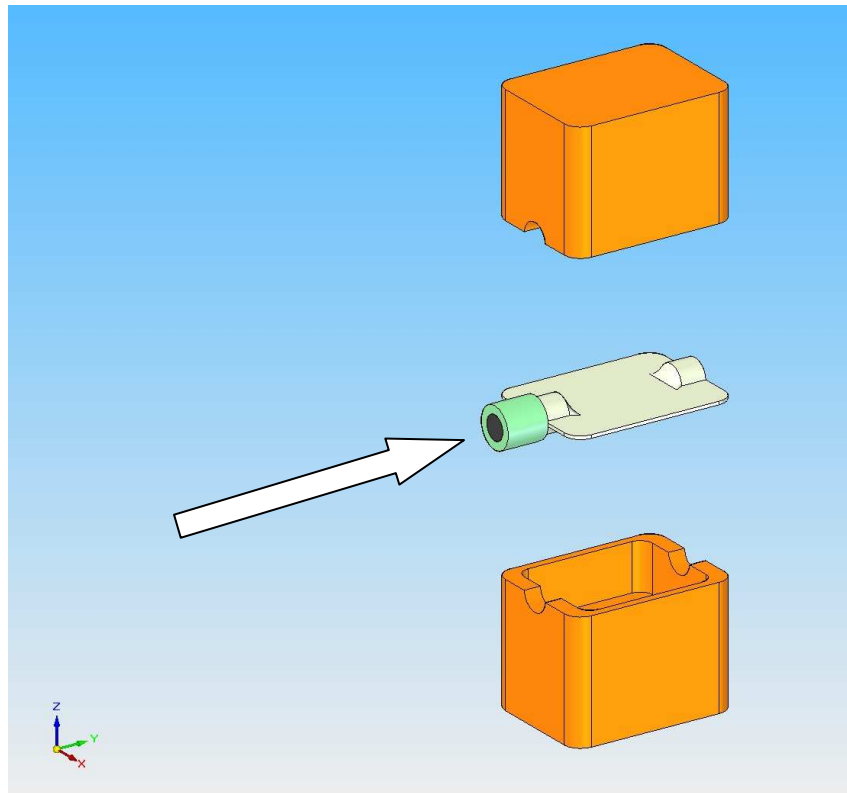

Operation

Preparing

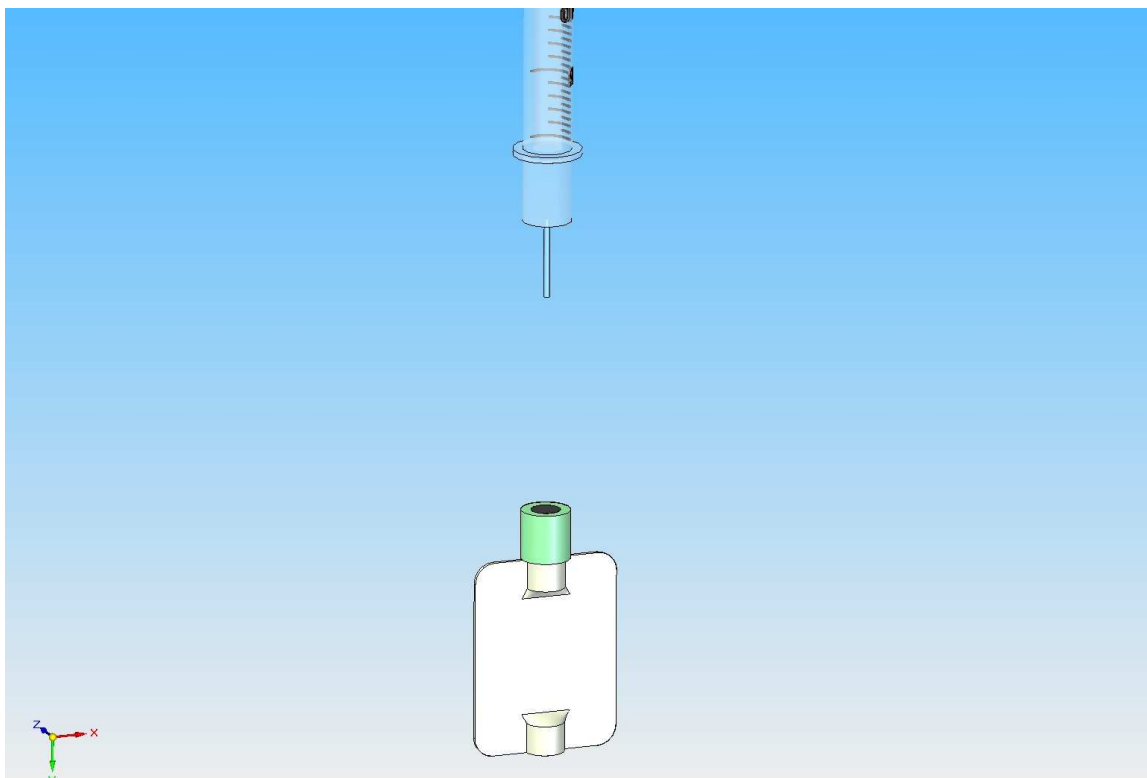

Insert the syringe

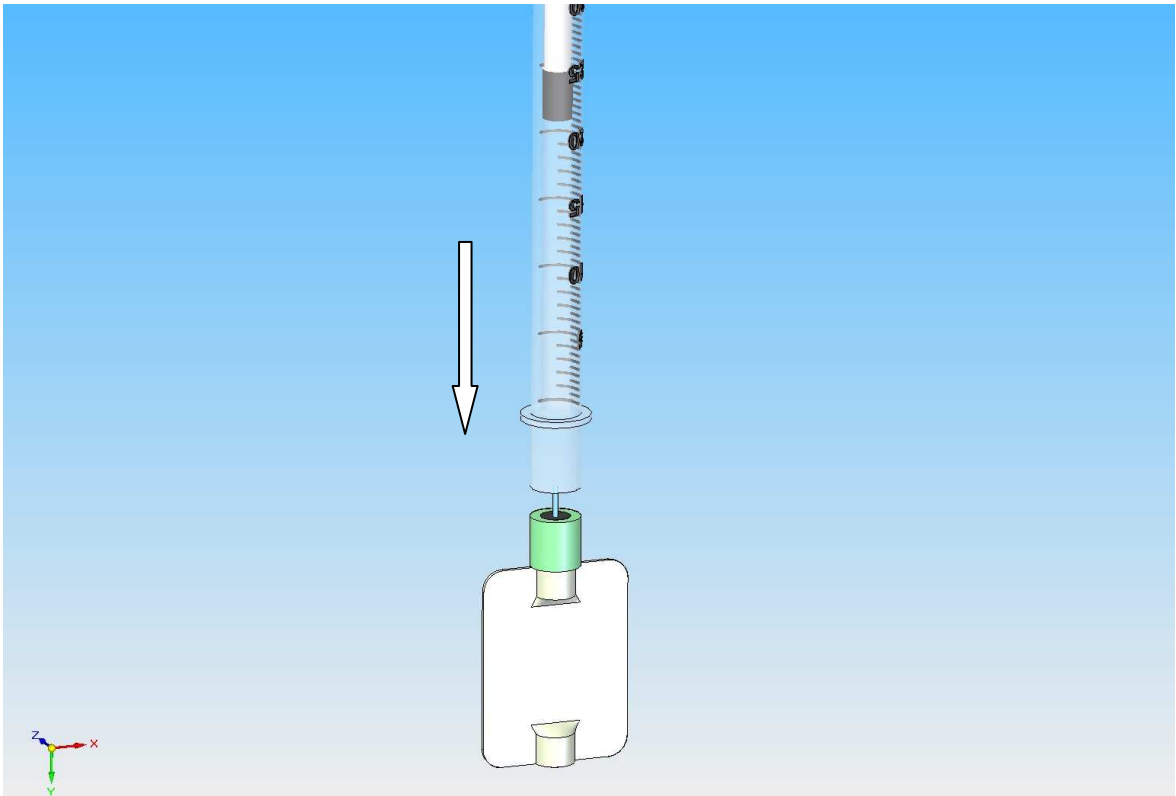

Inject the insulin and extract the air at the same time

